

DESKPOWER[™] DB4/DL4 systems



To learn more about LINAK please visit:
WWW.LINAK.COM

Contents

Preface	4
Safety instructions	5
Before installation, reinstallation or troubleshooting	5
Before start-up	5
During operation	5
Repairs	6
Manufacturer's declaration	6
Misc. on the DESKLINE® DESKPOWER system	7
Warranty	7
Maintenance	7
The DESKLINE® DESKPOWER system	7
Mounting guidelines for the DESKPOWER DB4 system	8
Mounting guidelines for the DESKPOWER DL4 system.....	10
Mounting guidelines CBD4/CBD5	12
Operation of the DP	13
Operation of the DP1C	14
Operation of the WDPL.....	16
Calibrating the WDPL	18
Electrical connection.....	23
Initialisation of the DESKPOWER DB4/DL4 system.....	24
Anti-Collision™	25
Labels	26
Drawing appendix	27
Declaration of conformity	31
Addresses	32

Preface

We are delighted that you have chosen a product from LINAK A/S. LINAK systems are high-tech products based on many years of experience in the manufacture and development of actuators, electronic control boxes, controls and chargers. We are also constantly improving our products to meet customer requirements.

This User Manual will tell you how to install, use and maintain your LINAK DESKLINE® products.

We are sure that the DESKLINE products will give you many years of problem-free operation. Before our products leave the factory they undergo full function and quality testing. Should you nevertheless experience problems with your systems, you are always welcome to contact our service departments or service centres.

LINAK subsidiaries and distributors all over the world have authorised service centres, which are always ready to help you.

LINAK provides a warranty on all its products. This warranty, however, is subject to correct use in accordance with the specifications, maintenance being done correctly and any repairs being carried out at a service centre, which is authorised to repair LINAK products.

Changes in installation and use of LINAK systems can affect their operation and durability. Changes must therefore only be made by agreement with LINAK A/S and are made at your own risk.

LINAK A/S

Safety instructions



Safe use of the system is possible only when the operating instructions are read completely and the instructions contained are strictly observed.

Failure to comply with instructions marked with the "NOTE" symbol may result in serious damage to the system or one of its components.



It is important for everyone who is to connect, install or use the systems to have the necessary information and access to this User Manual.



If there is visible damage on the product it must not be installed.



The appliance is not intended for use by young children or infirm persons without supervision.



Young children should be supervised to ensure that they do not play with the appliance.

Before installation, de-installation or troubleshooting

- Stop the DB4/DL4
- Switch off the power supply and pull out the mains plug.
- Relieve the DB4/DL4 of any loads, which may be released during the work.

Before start-up:

- Make sure that the system has been installed as instructed in this User Manual.
- Make sure that the voltage at the control box is correct before the system is connected to the mains.
- System connection. The individual parts must be connected before the control box is connected to the mains. See the User Manual for LINAK actuators, if necessary.

During operation:

- If the control box makes unusual noises or smells switch off the mains voltage immediately.
- Take care that the cables are not damaged.
- Unplug the mains cable on mobile equipment before it is moved.

Repairs

In order to avoid the risk of malfunction, all DESKLINE® repairs must only be carried out by authorised LINAK workshops or repairers, as special tools must be used and special gaskets must be fitted. Lifting units under warranty must also be returned to authorised LINAK workshops.



Warning!

If any of the DESKLINE® products are opened, there will be a risk of subsequent malfunction.



Warning!

The DESKLINE® systems do not withstand to cutting oil.

Manufacturer's declaration

**Implementation with regard to the Community
legislation on machinery**

Directive 98/37/EC attachment II B:

LINAK A/S, subsidiaries or representatives,
(see back cover)

prohibit that actuators are put into service
until the machinery into which the actuator is to be
incorporated has been declared in conformity with
the provisions of all relevant Directives.

Bent Jensen
LINAK A/S

Misc. on the DESKLINE® DESKPOWER system

Warranty

There is an 36 months' warranty on the DESKLINE products DB4, DL4, CBD4, CBD5, DP, DPA and DPB against manufacturing faults calculated from the production date of the individual products (see label). LINAK A/S' warranty is only valid in so far as the equipment has been used and maintained correctly and has not been tampered with. Furthermore the system must not be exposed to violent treatment. In the event of this, the warranty will be ineffective/invalid. For further details, please see LINAK A/S ordinary conditions of sale.

Maintenance

Clean dust and dirt on the outside of the system, at appropriate intervals and inspect them for damage and breaks.

Inspect the connections, cables and plugs and check for correct functioning as well as fixing points.



The cleaners and disinfectants must not be highly alkaline or acidic (pH value 6-8).

Description of the DESKLINE® DESKPOWER system

Each DESKLINE® DESKPOWER actuator/column is equipped with a motor and parallel/memory drive is ensured by means of software in the CBD4/CBD5 that also takes account of oblique load on the desk. Soft start and stop are also part of this software, which ensures a soft start and stop when adjusting the desk.

Application of the DESKLINE® DESKPOWER system:

Irrespective of the load the **duty cycle 10% ~ 6 min./ hour or max. 2 min. at continuous use** stated in the data sheets, must **NOT** be exceeded as this will result in a superheating of the motor and control box. Exceeding the duty cycle will result in a dramatic reduction of the life of the system.

The DESKPOWER system range contains following products:

- 1 control box CBD4/CBD5
- DB4 or DL4 (1 - 4)
- 1 exchangeable mains cable
- motor cables (1 - 4)
- 1 DP1U (if memory function is required) DP1C/WDPL (if memory function and display is required) or 1 DPA/DPB/DP1K (Desk Panel without memory)

Mounting guidelines for the DESKPOWER DB4 system

For detailed information on how to mount the DB4 please contact LINAK.

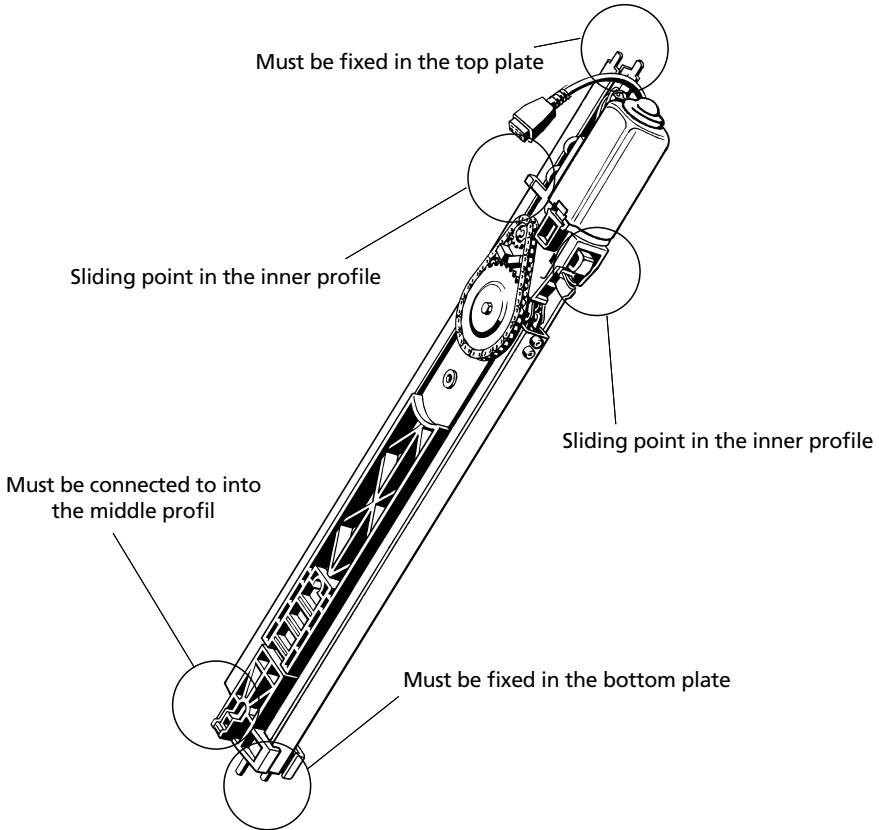

Figure 3
(DB4 fixing points)



The guidances must be secured against rotation.



The DB4 must not be activated when it is not mounted in guidance due to the risk of squeezing.



We recommend to mount DB4 so that the upper rail is fastened to the side with the highest moment load.

- Side slides must be adapted so that DB4 is parallel with the profiles and so that there is an easy slide fit between DB4 and the inner profile
- Bugs must be twisted opposite each other in an angle of approx. 80%
- The friction in the guidance must be max. 150-200 N
- The weight of the top frame + the desktop must be larger than the total friction in the guidances
- Fastening of DB4 in the middle profile must be strong enough to manage the maximum friction on the middle profile
- Customer guidances must be built into the desk with regard to conditions described in the DL4 section

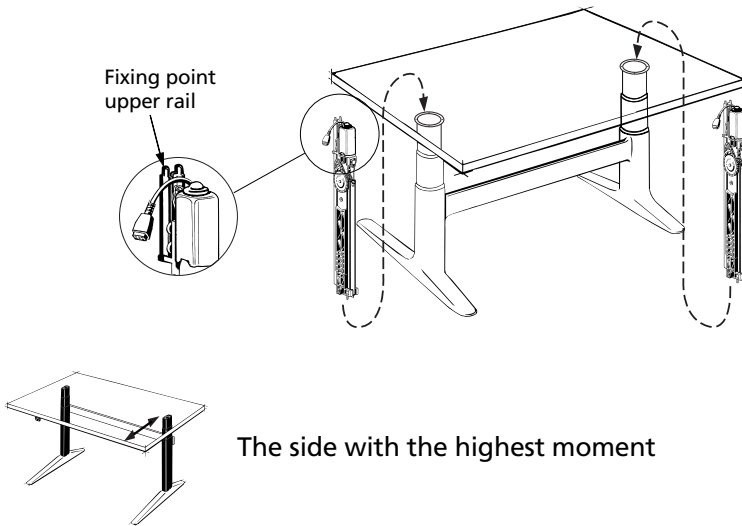

Figure 4
(Example of how to mount the DB4 system)



LINAK recommends that the DESKLINE® DB4 system should be used in push applications.



Placement of a monitor directly above the columns may cause malfunction of the monitor. Magnets inside the motor may interrupt the picture on the monitor depending on the distance and type of monitor.

Mounting guidelines for the DESKPOWER DL4 system

The mounting bracket for the crossbar is mounted on the largest profile. The cable is led out at the top of the small profile. This means that the column must always be mounted with the largest profile downwards.

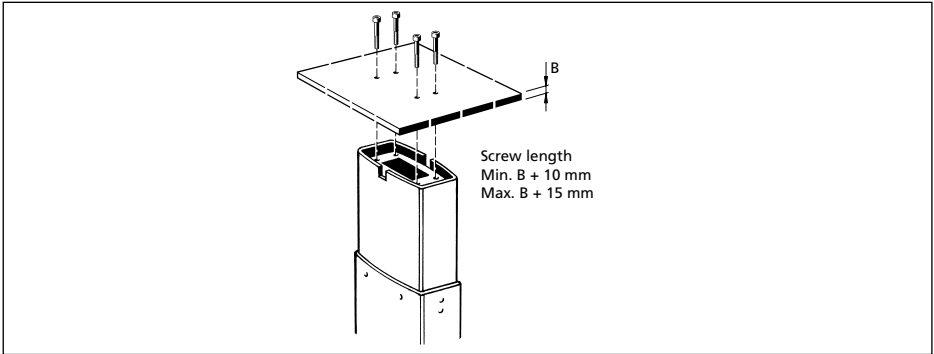

Figure 1



The mounting of the bottom part is analogue to the top part shown in Figure 1.

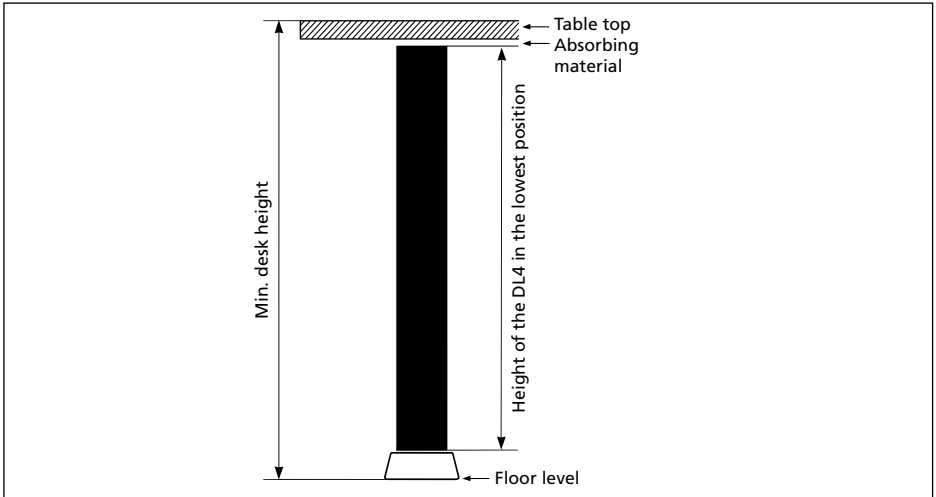

Figure 2

A suitable desk height in the lowest position can be obtained by mounting the lifting unit on a 6-8 mm bottom plate by means of 4 pcs. of M6 countersunk screws. We recommend you to use screws of min. quality 8.8. The thrust moment must not exceed 10 Nm in the top and bottom plate thread.

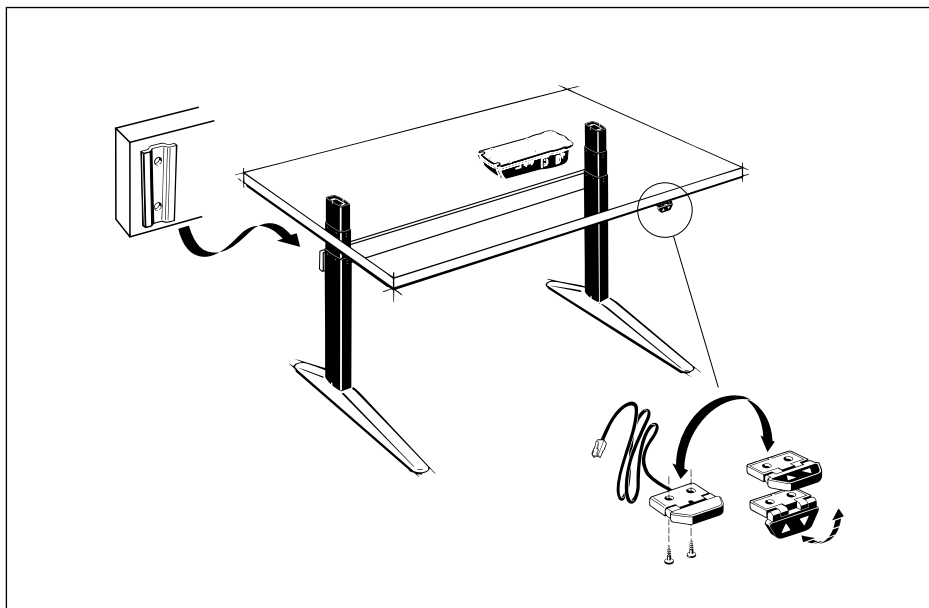

Figure 3
*(Example of how to mount a 2 parallel DESKLINE®
 DESKPOWER DB4/DL4 system)*



LINAK recommends that the DESKLINE® DESKPOWER DL4 system should be used in push applications.



Placement of a monitor directly above the motor may cause malfunction of the monitor. Magnets inside the motor may interrupt the picture on the monitor depending on the distance and type of monitor. If this is the case the problem may be solved by placing an iron plate/tube or another magnetic material, somewhat larger than the profile between the motor and the tabletop.



The mounting screws on the DP, DPA or DPB must be fastened with a max. torque of 1 Nm.



The DL4 is mounted with a conical dovetail bracket (female). On the crossbar the counterpart of this bracket must be mounted (male). This bracket can be ordered at LINAK.

When mounting the bracket onto the crossbar you must be careful to mount the brackets perpendicular to the crossbar and that the centre distance of the bracket fits exactly with the centre distance of the legs in the top frame bore of the desk (oblong holes in the top frame gives adjustable centre distance).

When the crossbar is mounted onto the legs it must be tightly fixed with a plastic hammer to obtain the maximum stability.

The bracket has to be fully welded in both ends not through the holes in the bracket (the bracket will bend). Do not mount extra brackets in a way that deforms the profiles.



When designing the desk/top frame and placing the control box you have to choose a design/a placement that ensures there is no risk of squeezing at the crossbar.

Mounting guidelines CBD4/CBD5

The control box is to be fastened with 4 screws (3 screws for CBD5) with a head diameter between $\varnothing 8$ and $\varnothing 10$ mm. Out of regard for the tension surface $\varnothing 10$ mm is preferable. See drawing appendix for placing of mounting holes and the space the CBD takes up.

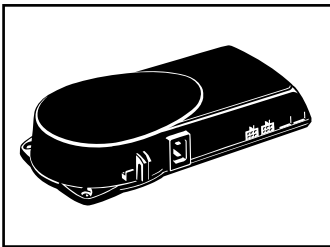

CBD4 - Control box



CBD5 - Control box

The CBD must not be packed in heat insulating material, but must be placed so that it can emit waste heat into the surroundings. There are no ventilation holes to consider, the CBD emits heat through the surface.







The plug must be visible when the CBD is mounted so that the supply to the CBD can be disconnected at replacement, if any.

The mounting screws on the control box must be fastened with a max. torque of 1 Nm.

The mounting surface to which the control box is attached should have a surface evenness of better than ± 0.5 mm.

Operation of the DP

The Desk Panel is used to operate the DESKLINE® system. The DP is available in 3 versions DPXK/DPA/DPB for single/parallel drive without memory and DP1U for single/ parallel drive with memory (3 memory positions). The two arrow buttons are used for single/ parallel drive and the last four buttons for memory drive.

-  Desk up
-  Desk down
-  Memory 1
-  Memory 2
-  Memory 3
-  Store memory

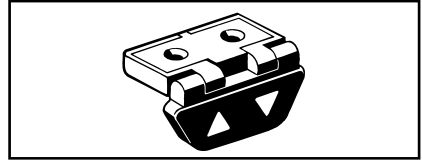

DPA - Desk Panel

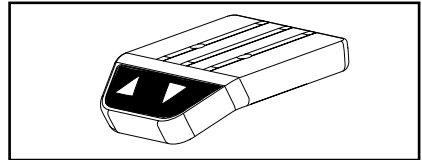

DPB - Desk Panel

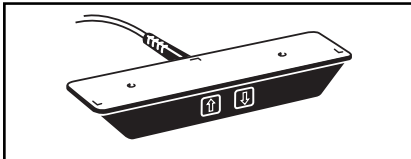

DP1K - Desk Panel

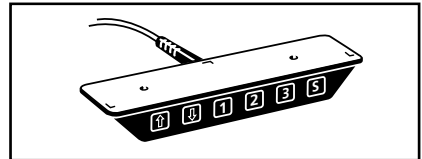

DP1U - Desk Panel





Single/parallel drive

The arrow buttons start the DL4/DB4. The function is only activated when holding down the button.

Memory drive

Memory 1, 2 and 3 start a memory drive, the channel(s) drive to a pre-programmed position.

Store memory







- Push 
- Within two sec. push either ,  or 

Operation of the DP1C

DP1C can not be used on CBD4 with mains cut-off.

Description

The DP1C is equipped with display and memory and is compatible with CBD4 (Advanced, software 077402 ver. 1.66 or later). The DP1 is only available as a 1-channel version for operation of the parallel channels up and down. The actual height of the desk is shown in the display. The display is of the LED type with a yellow light and 10 mm high digits.

	Desk up
	Desk down
	Store memory
	Memory 1
	Memory 2
	Memory 3



Normal operation:

To run the desk up or down, press the UP or DOWN button, and keep it pressed until the desk reaches the desired height. The display will count up or down while running, and after stop it will continually show the current height of the desk.

Changing between cm and inches:

Keep the S button pressed for approx. 4 sec. and the reading will change from the current setting. The default setting depends on the type chosen.

Store a memory position:

Press the "store" button the display will flash "S" for 3 sec. Within the 3 sec. press memory button 1, 2 or 3. The display will acknowledge by showing S1, S2 or S3 for 1 sec. To abort a store sequence press the UP or DOWN button while the "S" is flashing, or wait the 3 sec. until the display automatically returns to show the height of the desk.

Drive to a stored position:

Version with "GO-memory"

Press memory button 1, 2 or 3. The display will flash "GO1", "GO2" or "GO3" for 3 sec. Within the 3 sec. press the UP or DOWN button and keep it pressed until the desk stops in the stored position. Both the Up and the Down button will activate memory drive. Although e.g. the memory position is higher than the actual height, it will drive upwards when you press the Down button. While running to a memory position the display

will show GO1, GO2 or GO3, and when it stops in the stored position, the height of the desk will be shown. Releasing the UP or DOWN button will abort the memory drive. The display will show the height of the desk.

Version with "standard memory"

Press memory button 1, 2 or 3 and the system will start driving to the wanted memory position. Keep the button pressed until the position is reached. The display will show the actual height during the memory run.

Adjust the display to show the correct height:

It may be necessary to adjust the display due to different thicknesses of desktops etc, when the DP is delivered from the factory. The DP will show 68 cm or 22.5 inches (default setting) height of the desk. At the same time press the "Store" button and step UP or DOWN, until the display shows the correct height.

Adjusting the light intensity of the LED display

Possible light settings are: 0= off, 25 = 25%, 50 = 50%, 75 = 75%, 100 = 100%.

Adjustment procedure

Press the "1" button and at the same time either "desk up" or "desk down" this will adjust the light intensity. Initial press will show the current setting. Keep the "1" button pressed during the whole sequence while adjusting up or down. Keep a button pressed for more than 800 msec then the button will auto repeat every 100 msec. Releasing all buttons stores the new setting.

Adjusting the light timeout

Possible light timeouts are: 0-15 sec and off

Adjustment procedure

Press the "3" button and at the same time either "desk up" or "desk down" this will adjust the light timeout. Initial press will show the current setting. Keep the "3" button pressed during the whole sequence while adjusting up or down. Keep a button pressed for more than 800 msec then the button will auto repeat every 100 msec. Releasing all buttons stores the new setting.

Errors

Below please find the possible errors which can be displayed. The errors will only be displayed when a button is pressed. The display blinks while showing the error. E16 overrules any other error as the detection is registered only in the display and no message is sent to the control box.

continued....

Error no.	Description
E01	The desk has an unknown position and need to be initialized.
E02	Overload upwards has occurred.
E03	Overload downwards has occurred.
E16	Illegal keys pressed.

Diagnostic errors

The CBD4 (version 1.86 or later) can send up to 6 different diagnostic error codes at the same time. The diagnostic error codes will overrule error states (except E16). Diagnostic errors will only appear as long as the button is pressed. The display will blink EXX and will toggle through the diagnostic errors and send them to the LINBUS in the CBD. For detailed error description and codes please see the appropriate CBD software description. (Only working with DP1C from production date 1.february 2006 and onwards)

Operation of the WDPL

The batteries:

Wired WDPL: Install 3 x 1.5 V batteries type AA. The batteries are used as a backup of the clock function if the CBD is disconnected from the mains.

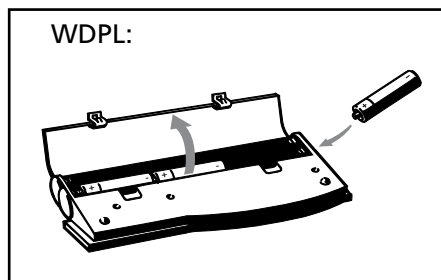

Figure 9

When the batteries are mounted the display will show the clock function in hh:mm. The clock has to be adjusted. **See adjusting the clock on page 19.**

Low battery:

Change batteries at weak contrast in the display or when the display shows strange symbols/misinformation.

This does not influence the function of the WDP - it is exclusively a sign that the batteries are to be replaced.

The WDPL will also work without batteries because it will be powered by the control box.

The WDPL will also work on a CBD4/CBD5 with mains cut off. The clock will only be shown if you have battery back-up.

The cable from the WDPL is connected to the control box under your table:

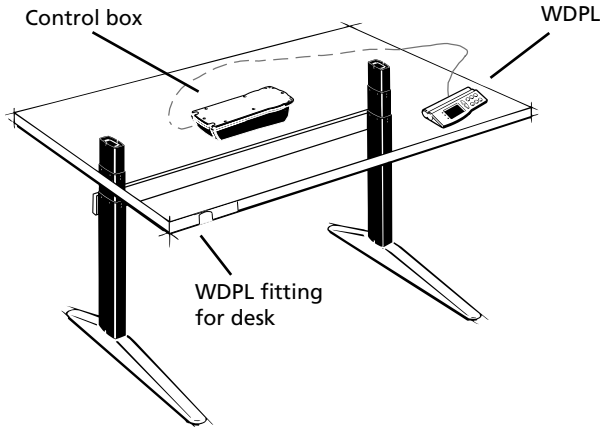
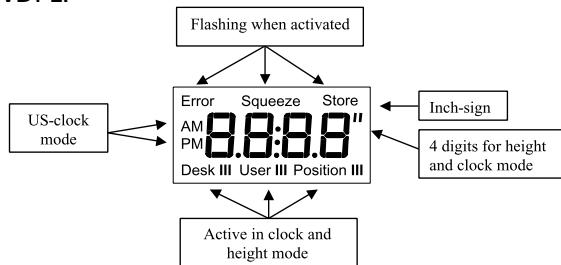





















Figure 11

Display layout - WDPL:



Calibrating the WDPL

For the WDPL to function correctly you have to calibrate your system. This has to be done before using the WDPL. You only have to do this once.









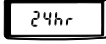

Action:	Display view:
<p>1. Switch between [cm] and [inch]. Press and hold  and then press .</p> <p>2. Measure the height from desk to floor. If only one desk is connected, - go to point 4.</p> <p>3. Press  and then press ,  or  to select desk. If only one desk is connected it is not possible to select Desk II or III.</p> <p>4. Press and hold  and then press  or  to adjust the height in the display. Example: The display will switch from e.g. 68 to 69, 70, 71 etc. when  is pressed and held and then  is pressed. and e.g. 68 to 67, 66 etc. when  is pressed and held and then  is pressed.</p> <p>5. When the wanted height is shown in the display press and hold  and then . The reference height of the desk will now be stored in the control box. When the reference height is stored the digits will be switched off for 1 sec. and back on again.</p>	<p> Desk I User I</p> <p> Desk I User I</p> <p> Desk I User I</p> <p> Desk I User I</p>

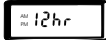
If the buttons are not activated for 15 sec. the clock function will appear in the display.

It is not necessary to repeat calibration when changing batteries.

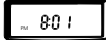
Adjusting the clock

Example:

Action:	Display view:
<p>1. Press the "clock button" using a ball pen. 24hr mode (European time mode) is default - can be changed to 12hr mode (US time mode)</p>	 <p>Flashing</p>
<p>Changing time mode:</p>	
<p>Press  or </p>	 <p>Flashing</p>
<p>(Press the "clock button" again to confirm "time mode" using a ball pen)</p>	 <p>hh is flashing</p>
<p>2. Press  or  to adjust "hh"</p>	 <p>Switches to PM if hh > 11</p>
<p>3. Press the "clock button" again to confirm "hh".</p>	 <p>mm is flashing</p>
<p>4. Press  or  to adjust "mm"</p>	
<p>5. Press the clock button again to confirm "mm"</p>	

The clock is now activated.

















Store a memory position

3 users can store 3 memory positions each. The connected desks (max. 3) are to be adjusted individually - one at a time.

Quick setup:

On the back of the WDP you will find a quick guide for storing a memory position.

Example:

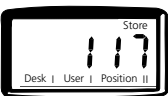
Action:	Display view:
<p>If only one desk is connected, - go to point 4.</p> <ol style="list-style-type: none">1. Press 2. Press  ,  or  until the wanted desk is shown in the display.3. Press 4. Press  ,  or  until the wanted user is shown in the display5. Press  or  until the wanted height is obtained.6. Press  and then  ,  or 	<p> Desk I User I Flashing</p> <p> Desk I User I Flashing</p> <p> Desk I User I</p> <p> Store Desk I User I Position II</p>

The position is now stored in the control box.

To store a new memory position on the same desk go through points 3 to 6 again.









If the buttons are not activated for 15 sec. the clock function will appear in the display.

Switch to a stored memory position

Quick setup:

On the back of the WDP you will find a quick guide for storing a memory position.

Example:

Action:	Display view:
<p>1. Press </p> <p>2. Press  ,  or  until the wanted user is shown in the display</p> <p>3. Press and hold  ,  or  until all desks have reached their memory position.</p> <p>The display will show the height of the moving desk for about 15. sec.</p>	<p> Desk I User III Flashing</p> <p> Desk I User III Position I</p> <p>Position I is flashing - digits counting from 117 to 88. When the desk has reached the new height position I it will stop flashing.</p>

If the buttons are not activated for 15 sec. the clock function will appear in the display.

Troubleshooting:

At errors the error code appears from the display - The "error" segment flashes (1 Hz).

Error code	Description of the error	Trouble shooting
E-01	Position lost	Initialise
E-02	Overload in upward direction	Remove heavy objects from the desk
E-03	Overload in downward direction	Remove objects that prevents downwards operation
E-16	Illegal push on key	Release all buttons and activate valid button / button combination
Flashing frame	No contact to the control box	Check that the control box is turned on. Check that the display is within the specified range.

Electrical connection of the DB4/DL4 system:

The DESKPOWER systems is to be connected as shown on figure 7. Each DB4/ DL4 is to be connected to the sockets on the control box by means of the motor cables, which have an 6-pin plug in each end.



Finally the mains cable is to be mounted and power switched on.

Please note that the control box must only be connected to the voltage stated on the label.

CBD4/CBD5 with earth

The CBD4/CBD5 earth cable to be mounted on the desk construction (typically the top frame) in a way that ensures good electrical contact. The function of the earth cable is to earth the desk and ground static electricity. The earth connection does not protect other electrical products.



CBD4/CBD5 with mains cut off

If the power cable is damage it has to be replaced by an authorized LINAK servicecenter to avoid any danger.

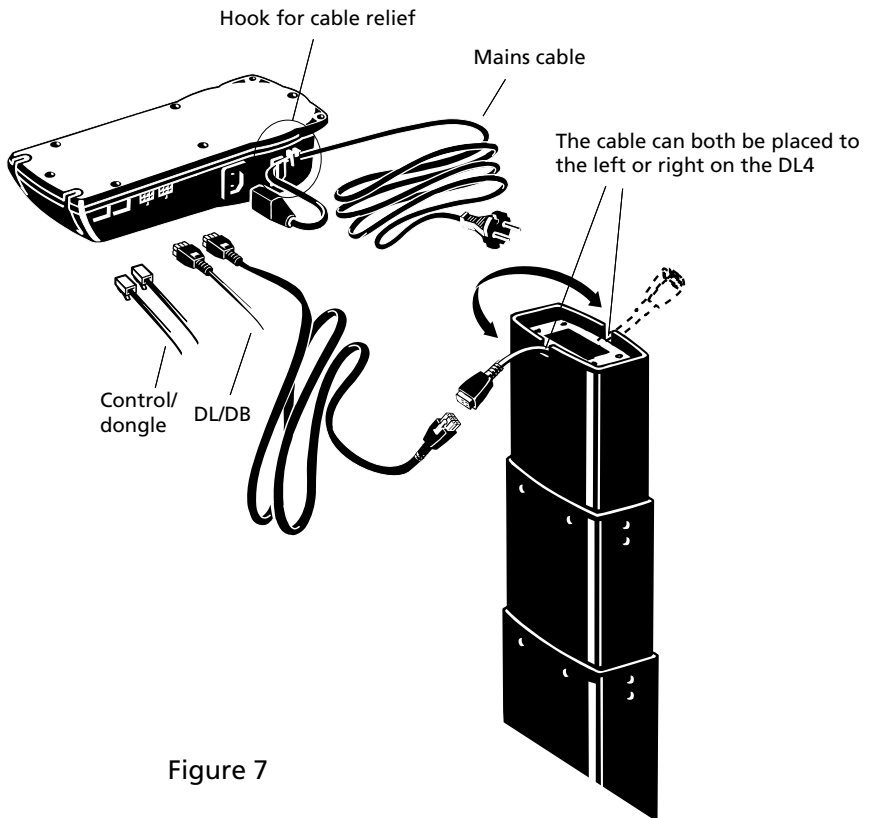

Figure 7

Initialization of the DESKLINE DB4/DL4 parallel systems

The DESKPOWER system is initialized by pressing the down button once or twice and holding it down until DB4/DL4 runs into end stop, it will then automatically run approx. 5 mm out again hereafter slowly running in again. Only release the down button when the movement has completely stopped.



If the button is released before the sequence is complete then the initialization is interrupted and must be started again from the beginning.

It is sometimes necessary to press the down button twice to start the initialization, this is because the system can be in different modes when the initialization starts. There will be a 1.25 sec. delay. If an error situation occurs at the end stop positions or DB4/DL4 are changed to another stroke length, then CBD4/CBD5 has to be initialized again.

The first two times the system run into the outwards end stop, it will automatically run approx. 3 mm back in inward direction.

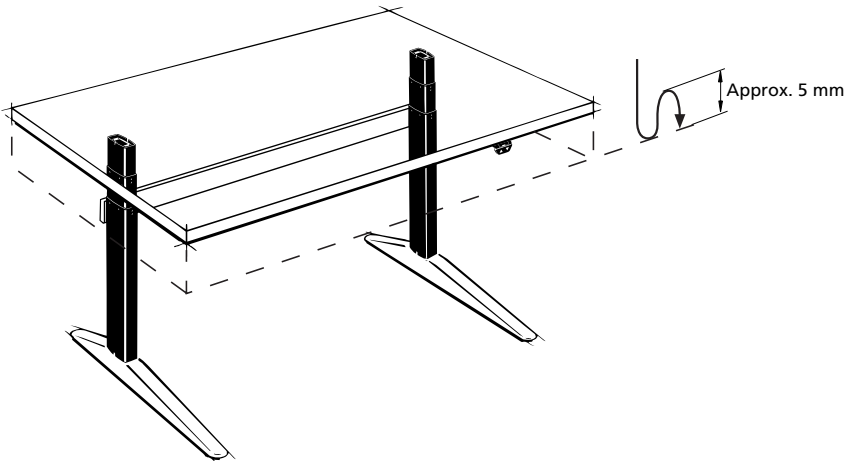

The CBD5 can control DB5 and DB6 in 2 parallel and 3 parallel while the CBD4 can control DB5 and DB6 in 2, 3 and 4 parallel so that the desk is always kept horizontal.

Anti-Collision™ (only for DL4, DL6, DL9 and DL11)

The function anti-collision is a new option for the standard CBD4/CBD5 advanced/ control box software version 1.66 and later. A system with anti-collision can limit material damages on a desk if a collision with a solid object should occur.

Enabling the anti-collision

To enable the anti-collision function a little plug called a dongle must be mounted in one of the 2 control ports. The function is only active when the dongle is mounted. –If you remove the dongle again you disable the function.

Method of operation

When the DL/DB's are running the CBD4/CBD5 monitors the current consumption on each channel using a special algorithm. If the current consumption on one channel is increased more than a predefined slope a collision is assumed and all channels are stopped immediately and all DL/DB's will start to run in the opposite direction (approx. 50 mm). This return drive is done automatically and continues with or without any control key pressed (for max. 2.5 sec.).

The anti-collision sensitivity is different in up and downwards direction. Upwards the force is approx. 20 kg. Downwards the load will be approx. 40 kg + the load on the DL/DB (the desk + what is on top of the desk). The 40 kg are needed to activate the anti-collision function.

Situations where the anti-collision does not work

There are situations where the anti-collision will not be activated. These situations are:

- If the collision happens during the initialisation phase
- If the collision happens within the first 1000msec or after the control button has been released
- If the collision happens between the floor and the table and the load on the desk + the weight of the legs are lower than 40 kg
- If the collision happens over too long time, e.g. if the collision is with a soft object

Labels for CBD4 and CBD5

LINAK® 
WE IMPROVE YOUR LIFE

Item : CBD4C00030A-309
Date : 2006.05.09
U In : 230 V ~, 50 Hz
P In : 600 W
U Out: 18 VDC
Op. : 10%, Max. 2 min./18 min.
S.W. P/N. 0077402 Ver. 1.66



CAUTION: 
Not to be opened by unauthorized personnel
P.O.123456-0000

LINAK® 
WE IMPROVE YOUR LIFE

Item : CBD5P00020A-009
Date : 2006.05.09
U In : 230 V ~, 50 Hz
P In : 500 W
U Out: 18 VDC
Op. : 10%, Max. 2 min./18 min.
S.W. P/N. 0077429 Ver. 1.00



CAUTION: 
Not to be opened by unauthorized personnel
P.O.123456-0003

Labels for DL4, DP and WDP

LINAK® 
WE IMPROVE YOUR LIFE

Item No. DL4000A00675560
Prod. Date 2006.05.09
Max. Load 700 N
Power Rate 18 V ~ Max. 7.3 Amp
Duty Cycle 10%, Max. 2 min./18 min.
NOT TO BE OPENED BY UNAUTHORIZED PERSONNEL 

MADE BY LINAK A/S DENMARK 

P.O.123456-0001

LINAK® 
WE IMPROVE YOUR LIFE

Item: DP1000-000001
Date: 2006.05.09
P.O.: 123456 - 0000





MADE BY LINAK A/S DENMARK 

NOT TO BE OPENED BY UNAUTHORIZED PERSONNEL

LINAK® 
WE IMPROVE YOUR LIFE

Item : WDPL1000-000001 IP40
Date : 2006.05.09
P.O. : 123456 - 0000
S.W. P/N. 0077006 Ver. B1.11



MADE BY LINAK A/S DENMARK 

NOT TO BE OPENED BY UNAUTHORIZED PERSONNEL

Label for DB4

LINAK® 
WE IMPROVE YOUR LIFE

Type : DB4000X00440542
Item No. : DB40003
Prod. Date : 2006.09.12 S.O.654321
Max Load : Push 1000 N
Power Rate : 18 V ~ / Max. 7.3 Amp
Duty Cycle : 10 % , Max. 2 min. / 18 min.
NOT TO BE OPENED BY UNAUTHORIZED PERSONNEL 



P.O.123456-0001 MADE BY LINAK A/S DENMARK 

Label for DPA

The label is printed directly on the DPA

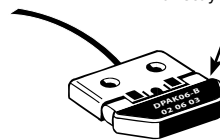

Label for DPB

The label is printed directly on the DPB

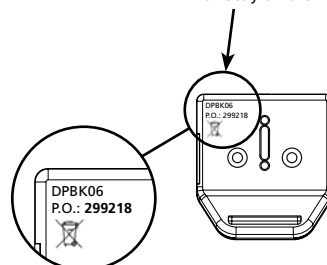

DRAWING APPENDIX

DESKLINE® DESKPOWER DB4/DL4 System:

DL4

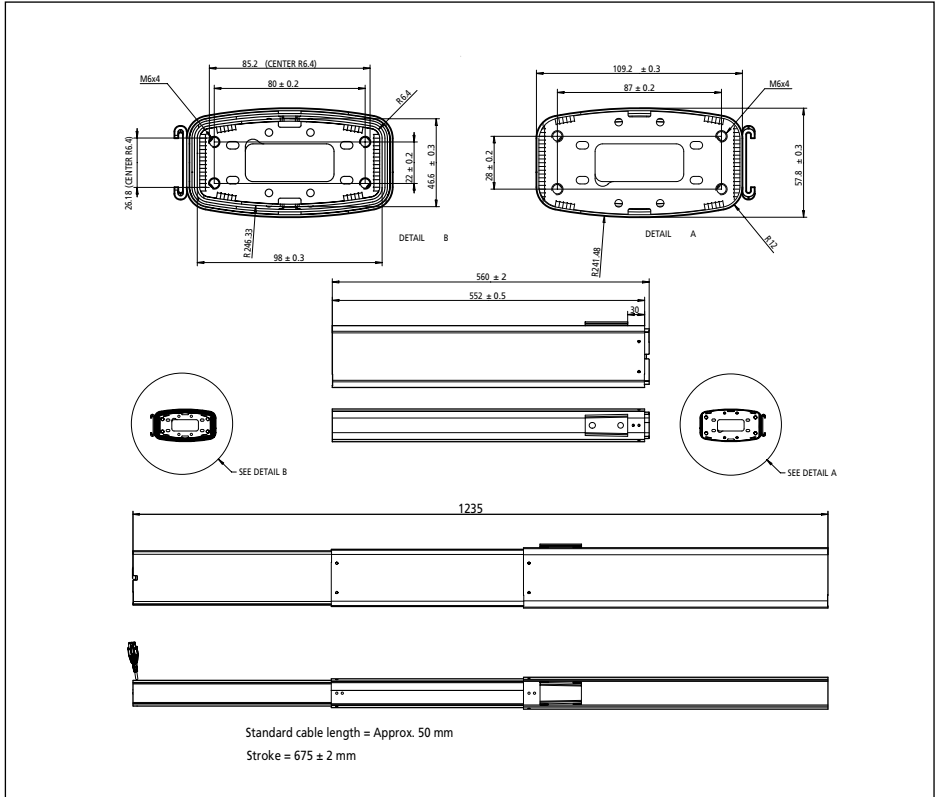

DB4

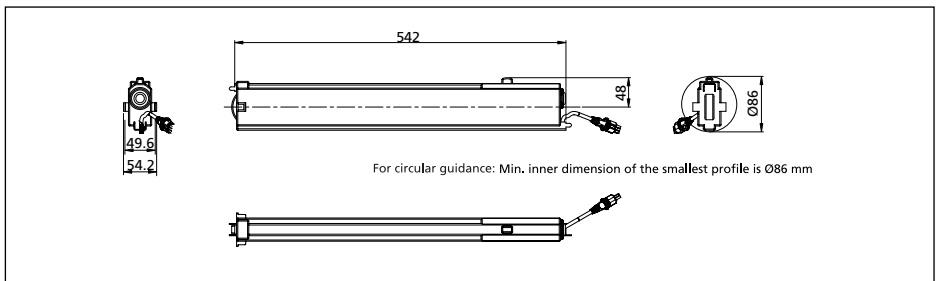

DPA

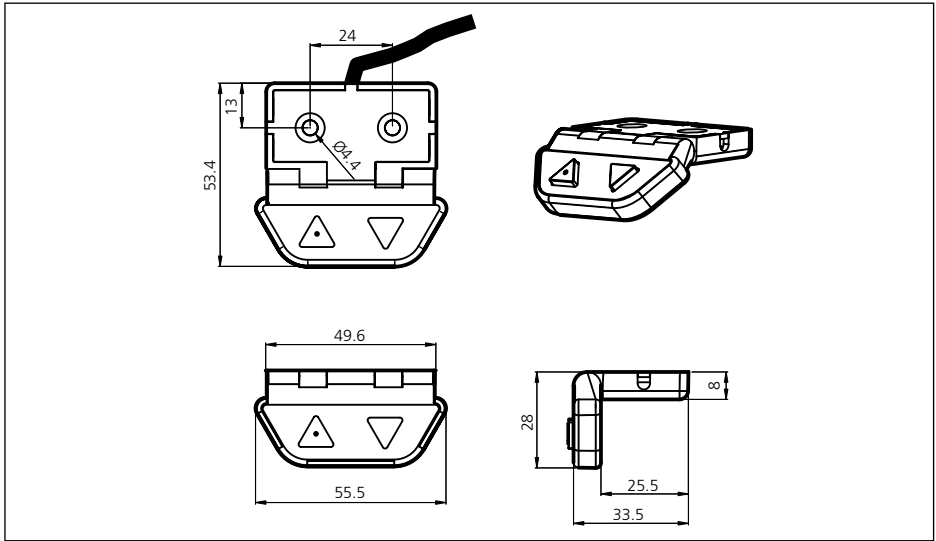

DPB

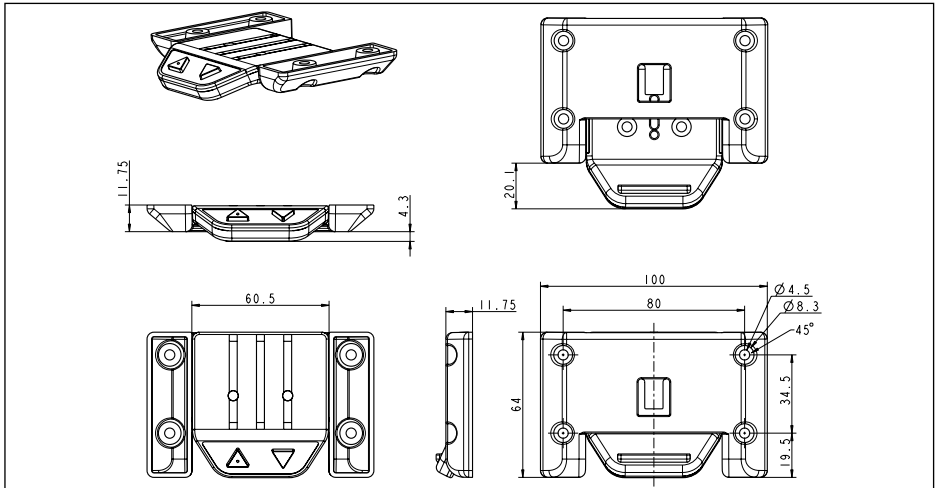

DP Desk Panel

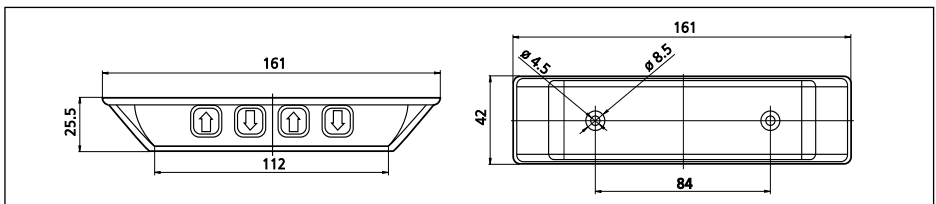

DP1C Desk Panel

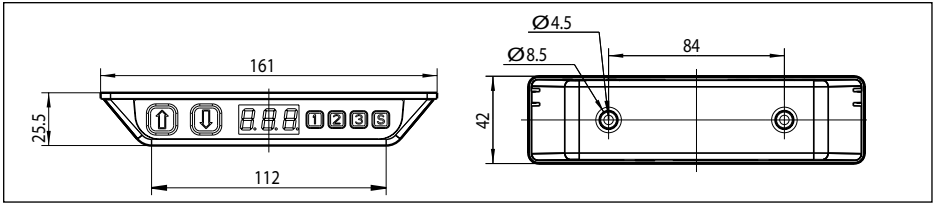

DP1U Desk Panel

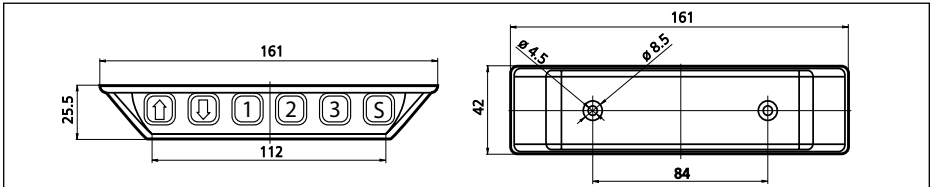

WDP

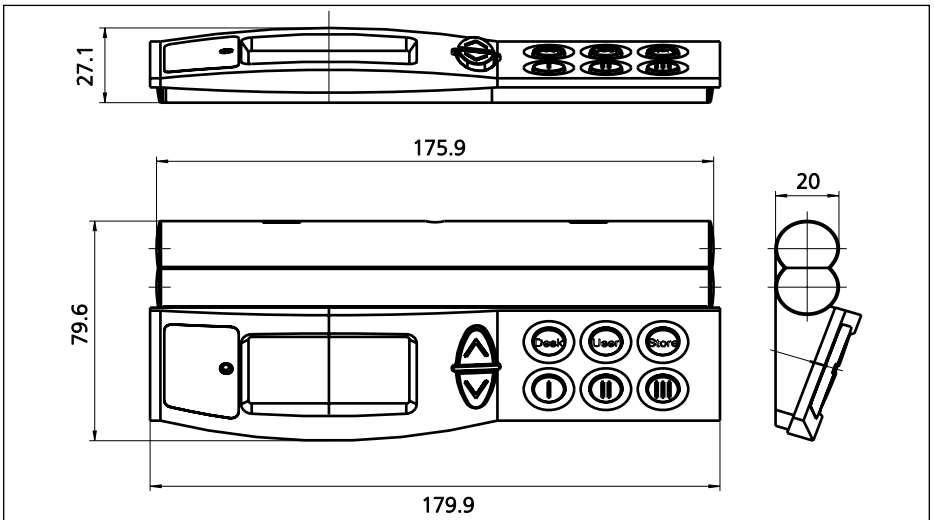

WDP fitting for desk:

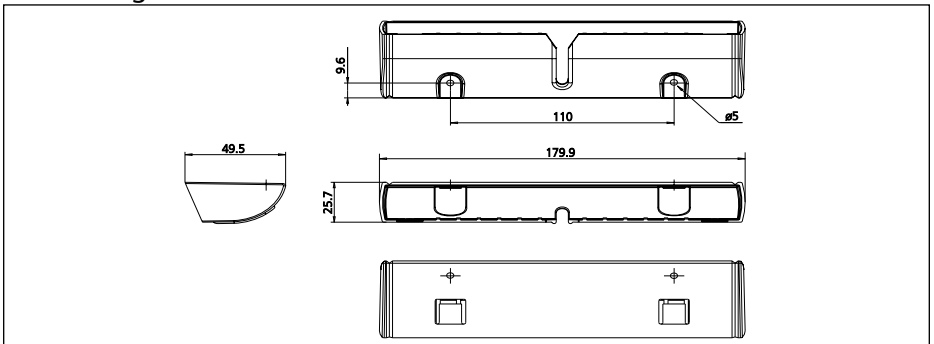

CBD4

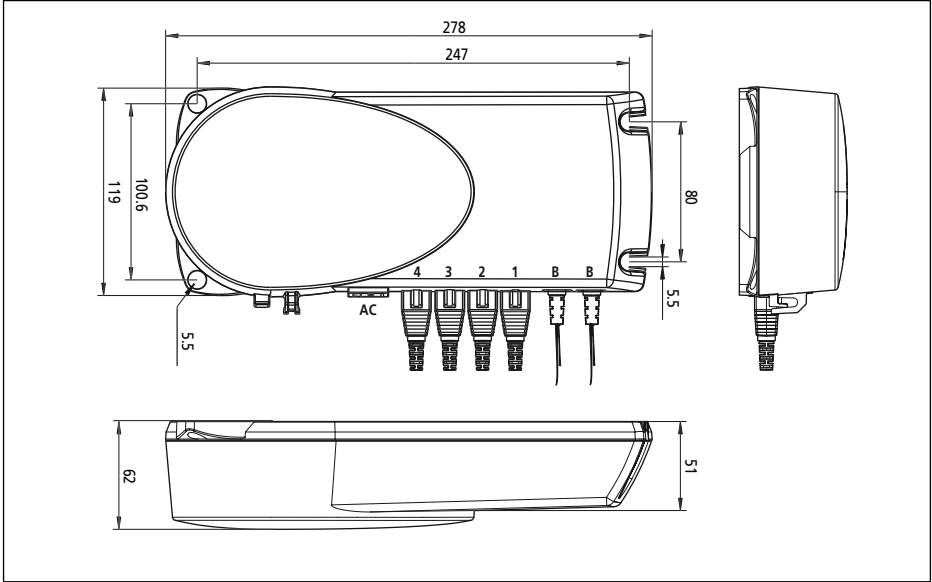

CBD5

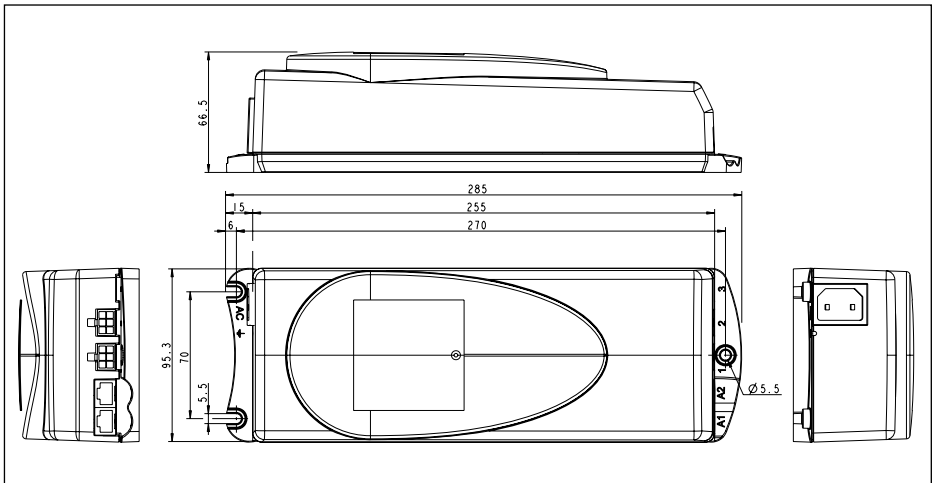

DECLARATION OF CONFORMITY

LINAK A/S
Smedevænget 8
DK - 6430 Nordborg

hereby declares that LINAK Actuator System composed of:

Control Box:
CBD4xxxxxxx-xxx or
CBD5xxxxxxx-xxx

Desklifts:
DL4xxxxxxxxxxx,
DB4xxxxxxxxxxx,
DL5xxxxxxxxxxx,
DB5xxxxxxxxxxx,
DB6xxxxxxxxxxx,
DL6xxxxxxxxxxx,
DL7xxxxxxxxxxx,
DB7xxxxxxxxxxx,
DL9xxxxxxxxxxx,
DB9xxxxxxxxxxx or
DL11xxxxxxxxxxx

Desk Panel/Display Panel:
DPAK06,
DPBK06,
DP1xxx-xxxxxx or
WDPL1000-000001

Cables:
0617100 (motorcable 1m) or
0617200 (motorcable 2m) or
0617250 (motorcable 2,5m) and
0015562 (mainscable)

complies with the EMC-directive 89/336/EØF according to the standards EN61000-6-1:2001, EN61000-6-3:2001

and complies with Low Voltage Directive 73/23/EØF according to the standard EN60335-1:1994, A1:1996, A12:1996, A13:1998, A14:1998

Machinery Directive 98/37/EC Attachment IIB: LINAK A/S prohibit that the actuator system is put into service until the machinery into which the actuator system is to be incorporated has been declared in conformity with the provisions of all relevant directives

Date: 2006-09-25

Signature:



(Hans Schou Christensen)

FACTORIES

CHINA

LINAK (Shenzhen) Actuator Systems, Ltd.
Phone: +86 755 8610 6656 · Fax: +86 755 8610 6990
E-mail: sales@linak.cn · www.linak.cn

DENMARK

LINAK A/S
Group Headquarters Guderup
Phone: +45 73 15 15 15
Fax: +45 74 45 80 48 · Fax (Sales): +45 73 15 16 13
E-mail: info@linak.com · www.linak.com

USA

LINAK U.S. Inc.
North and South American Headquarters
Phone: +1 502 253 5595 · Fax: +1 502 253 5596
E-mail: info@linak-us.com · www.linak-us.com

SUBSIDIARIES

AUSTRALIA

LINAK Australia Pty. Ltd
Phone: +61 3 8796 9777 · Fax: +61 3 8796 9778
E-mail: sales@linak.com.au · www.linak.com.au

BELGIUM & LUXEMBOURG

LINAK Actuator Systems NV/SA
Phone: +32 (0)9 230 01 09 · Fax: +32 (0)9 230 88 80
E-mail: info@linak.be · www.linak.be

BRAZIL

LINAK do Brasil Comércio de Atuadores Ltda.
Phone: +55 (11) 6832 - 7070 · Fax: +55 (11) 6832 - 7060
E-mail: linakbrasil@ig.com.br · www.linak.com.br

CANADA

LINAK Canada Inc.
Phone: +1 905 821 - 7727 · Fax: +1 905 821 - 4281
E-mail: info@linak.ca · www.linak.ca

CZECH REPUBLIC

LINAK C&S S.R.O.
Phone: +420581741814 · Fax: +420581702452
E-mail: ponizil@linak.cz · www.linak.cz

DENMARK

LINAK Danmark A/S
Phone: +45 86 80 36 11 · Fax: +45 86 82 90 51
E-mail: linak@linak-silkeborg.dk · www.linak.dk

FINLAND

LINAK OY
Phone: +358 9 8700 130 · Fax: +358 9 8700 1355
E-mail: linak@linak.fi · www.linak.fi

FRANCE

LINAK FRANCE S.A.R.L
Phone: +33 (0) 2 41 36 34 34 · Fax: +33 (0) 2 41 36 35 00
E-mail: linak@linak.fr · www.linak.fr

GERMANY

LINAK GmbH
Phone: +49 6043 9655 0 · Fax: +49 6043 9655 60
E-mail: info@linak.de · www.linak.de

INDIA

LINAK A/S India Liaison Office
Phone: +91 80 2212 0015 · Fax: +91 80 2207 2186
E-mail: info@linak.in · www.linak.in

IRELAND

LINAK UK Limited
Phone: +44(0)121 544 2211 · Fax: +44(0)121 544 2552
E-mail: stephen@linak.co.uk · www.linak.co.uk

ITALY

LINAK ITALIA S.r.l.
Phone: +39 02 48 46 33 66 · Fax: +39 02 48 46 82 52
E-mail: info@linak.it · www.linak.it

JAPAN

LINAK K.K.
Phone: 81 45 533 0802 · Fax: 81 45 533 0803
E-mail: linak@linak.jp · www.linak.jp

MALAYSIA

LINAK A/S Asian Representative Office
Phone: +60 4 210 6500 · Fax: +60 4 226 8901
E-mail: info@linak-asia.com · www.linak-asia.com

NETHERLANDS

LINAK Actuator-Systems B.V.
Phone: +31 76 5 42 44 40 · Fax: +31 76 5 42 61 30
E-mail: info@linak.nl · www.linak.nl

NEW ZEALAND

LINAK New Zealand Ltd.
Phone: 0064 9272 4411 · Fax: 0064 9272 4477
E-mail: nzsales@linak.com.au · www.linak.co.nz

NORWAY

LINAK Norge AS
Phone: +47 32 82 90 90 · Fax: +47 32 82 90 98
E-mail: info@linak.no · www.linak.no

POLAND

LINAK Poland
Phone: +48 32 246 08 08/09 · Fax: +48 32 247 19 77
E-mail: wsb@linak.pl · www.linak.pl

SPAIN

LINAK Actuadores S.L.
Phone: +34 93 588 27 77 · Fax: +34 93 588 27 85
E-mail: linakact@linak.es · www.linak.es

SWEDEN

LINAK Scandinavia AB
Phone: +46 8 732 20 00 · Fax: +46 8 732 20 50
E-mail: info@linak.se · www.linak.se

SWITZERLAND

LINAK AG
Phone: +41 43 388 31 88 · Fax: +41 43 388 31 87
E-mail: info@linak.ch · www.linak.ch

TAIWAN

LINAK A/S Taiwan Representative Office
Phone: +886 2 2713 2007 · Fax: +886 2 2718 2141
E-mail: info@linak.com.tw · www.linak-asia.com

TURKEY

LINAK A/S Turkey Representative Office
Phone: +90 312 4726338 - 59 · Fax: +90 312 4726635
E-mail: vozen@linak.com.tr · www.linak.com.tr

UNITED KINGDOM

LINAK UK Limited
Phone: +44(0)121 544 2211 · Fax: +44(0)121 544 2552
E-mail: sales@linak.co.uk · www.linak.co.uk

DISTRIBUTORS

ARGENTINA

NOVOTEC ARGENTINA SRL
Phone: +[54] (11) 4303 - 8900/89 · Fax: +[54] (11) 4032 - 0184
E-mail: info@novotecargentina.com
www.novotecargentina.com

COLOMBIA

MEM Ltda
Phone: +[57] (1) 334-7666 · Fax: +[57] (1) 282-1684
E-mail: servicioalcliente@memltda.com.co
www.memltda.com.co

ESTONIA

TECHTRADE OÜ
Phone: + 372 50 67040
E-mail: info@techtrade.ee · www.techtrade.ee

INDONESIA

PT. HIMALAYA EVEREST JAYA
Phone: +6 221 544 8956 / 65 · Fax: +6 221 619 4658 / 1925
E-mail: hejplastic-div@centrin.net.id

ISRAEL

Elsar Ltd.
Phone: +972 3 6438 490 · Fax: +972 3 6438 574
E-mail: info@elsar.com · www.linak.co.il

RUSSIAN FEDERATION

000 FAM
Phone: +7 812 3319333 · Fax: +7 812 3271454
E-mail: purchase@fam-drive.ru · www.fam-drive.ru

SINGAPORE

SERVO DYNAMICS PTE. Ltd.
Phone: +65 6844 0288 · Fax: +65 6844 0070
E-mail: servodynamics@servo.com.sg · www.servo.com.sg

SOUTH KOREA

UNITEK ENG.
Phone: +82 2 567 0888 · Fax: +82 2 3453 1177
E-mail: unitekeng@unitekeng.co.kr · www.unitekeng.co.kr

UNITED ARAB EMIRATES

Hydrolink
Phone: +971 6 528 0801 · Fax: +971 6 528 0830
E-mail: hydrolink@emirates.net.ae · www.hydrolinkuae.com

For contact details on other countries please visit
www.linak.com or contact:

LINAK INTERNATIONAL

Fax: +45 74 45 90 10
E-mail: info@linak.com · www.linak.com

The user is responsible for determining the suitability of LINAK products for a specific application.

LINAK A/S takes great care in providing accurate and up-to-date information on its products. However, due to continuing developments in order to improve its products, LINAK products are subject to frequent modifications and changes without prior notice. Therefore, LINAK cannot guarantee the correct and actual status of said information on its products. While LINAK uses its best efforts to fulfil orders, LINAK cannot, for the same reasons as mentioned above, guarantee the availability of any particular product. Therefore, LINAK reserves the right to discontinue the sale of any product displayed on its website or listed in its catalogues or other written material drawn up by LINAK.

All sales are subject to the Standard Terms of Sale and Delivery for LINAK A/S. For a copy hereof, please contact LINAK.



WE IMPROVE YOUR LIFE